

NEXUS

Closed circuit cooling towers

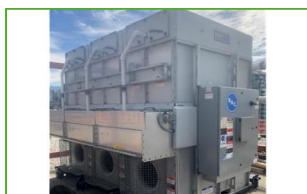

Key benefits

- Maximum Uptime
- Lowest operating costs
- Lowest environmental impact



NEXUS characteristics

Counter flow, radial fan, forced draft
Hybrid wet-dry cooling

Capacity range

up to 790 kW

Maximum entering fluid temperature

82 °C

Typical applications

- Small to medium HVAC and light industrial applications with focus on reliability, efficiency and minimal maintenance
- Tight enclosures and projects with height limitations
- Indoor installations
- Water saving requirements



Maximum Uptime

- Units are **CTI-Eurovent certified** which guarantees thermal performance and eliminates field thermal performance testing costs.
- Independent individual modules that **guarantee redundancy**.
- **Corrosion-resistant materials come standard** for maximum equipment life: stainless steel hCore™ Heat Transfer Technology combined with [Baltibond hybrid coating](#) on all structural components, with corrosion resistance equivalent to SST 304L.
- The cold water basin of the patent-pending **DiamondClear™ Design** can be **inspected while the unit is in operation**.
- EC Fan Systems are located inside the unit, in the dry air, preventing condensation and **eliminating corrosion issues** and premature failures.
- Direct driven fans **eliminate potential mechanical failures**.

Lowest operating costs

- Innovative **iPilot™ Control System** with patented intelligence operates in multiple modes to **optimize both water and energy savings** based on your needs and preferences.
- Patented hCore™ Heat Transfer Technology delivers **high thermal efficiency** (wet and dry) in a compact footprint, maximizing both water and energy savings.
- Patent-pending **DiamondClear™ Design** optimizes air distribution over the heat exchanger, provides **continuous self-cleaning**, reduces spray water volume by up to 60%, reduces water treatment and spray pump energy costs.
- **EC Fan System** has a **superior efficiency** that exceeds the requirements of efficiency class IE4. Integrated electronics of EC motors permit variable speed control for maximum system efficiency, at a significantly reduced power consumption.
- Energy efficient radial fans give up to 40% savings versus standard centrifugal fans and provide high external static capability.

Lowest environmental impact

- Patent-pending **DiamondClear™ Design** offers a continuous **self-cleaning operation**. During standstill the sloping surfaces fully drain hence avoiding stagnant water inside the unit and the risk of sedimentation of impurities.
- External collection basin with its **80% lower water volume** reduces the chemical usage and **eliminates the need to access the interior** for cleaning.
- Possibility to use water treatment systems that allow drainage from the hybrid cooler to surface water.
- Completely encased collection basin **eliminates any sunlight ingress**, preventing biological growth.
- Baltibond hybrid coating for a smooth surface finish that **reduces biofilm development**.
- Guarantee operational safety through the optional factory installed **chemical free UV biocide system**.



Lowest installation costs

- Can be installed as a **single piece** or as individual modules that **fit in a freight elevator** .
- Up to 35% less weight, 40% smaller footprint and 1,5 m lower height.
- **Plug & Play design** with innovative **iPilot™ Control System** and integrated electronics of EC motors, which eliminate external VFD's, electronic filters and on-site shielded cable wiring.
- Modular header included as standard for **single point process fluid connections**.
- **No passivation required** due to fully corrosion-resistant structure and hCore™ Heat Transfer Technology.
- Pressure capability of fans allows indoor installation with ductwork.

Lowest maintenance

- Patent-pending **DiamondClear™ Design** offers a continuous self-cleaning operation through fully sloping surfaces, a constant impact of falling spray water, high water velocities and 80% lower water volume (with no stagnant water inside the unit) **minimizing the need for maintenance** by reducing scale build-up and biological growth.
- The external cold water basin with spray pump, the direct drive fan in the dry system, the water distribution system and drift eliminator are all **easily accessible from the outside** without the need for any permanent ladders or elevated platforms.
- Swing-out EC Fan System allows easy inspection and requires **no maintenance** whatsoever.
- Inspection and maintenance of critical parts is possible during operation.
- [Baltibond hybrid coating](#) and stainless steel for a smooth surface finish that **facilitates internal cleaning**.

Interested in the NEXUS modular hybrid cooler for cooling your process fluid? Contact your local [BAC representative](#) for more information.

Downloads

- [Nexus Modular Hybrid Cooler](#)
- [Nexus Water Treatment Solutions](#)
- [NEXUS Closed circuit cooling towers](#)
- [Operating and Maintenance NXF](#)
- [Rigging and Installation NXF](#)
- [Spare parts for Nexus](#)

Principle of operation

Closed circuit cooling towers

Principle of operation

A Nexus™ Modular Hybrid Cooler consists of one or more modules, each with their own individual **hCore™ Heat Exchanger (1)**, **spray system (2)** and **EC Fan drive system (3)**.

When a module works evaporatively, the **warm process fluid (4)** circulates through the hCore™ heat exchanger, which is wetted by the spray system. At the same time, the EC fan drive system(s) blows **ambient air (5)** upwards through the heat exchanger. A part of the spray water evaporates and cools the process fluid, which then **exits the unit (6)**. The remaining spray water flows back into the **sloping external sump (7)**, where it is collected. A **spray water pump (8)** recirculates the water up to the spray system. The **warm saturated air (9)** leaves the cooler through the **drift eliminators (10)**, which remove water droplets from the air.

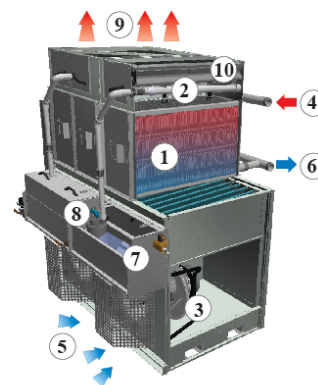

When a module works **dry**, the spray pump is turned off. Heat is now transferred from the process fluid to the ambient air using sensible heat transfer.

The **modular construction** and exclusive **iPilot™ Control System** of the Nexus™ enable **multiple modes of operation** to tailor water and energy performance to your needs. The embedded intelligence gives you the ability to **effectively balance water and energy savings** and achieve the lowest possible operating costs.



Energy saver mode

Energy savings are maximized by leveraging the full power of evaporative cooling. During periods when ambient temperatures or loads from the building or process are relatively high, the Nexus™ Modular Hybrid Cooler operates with all spray systems active across all modules. During off-design conditions, the EC Fan System will automatically and intelligently reduce speed whenever possible. As the load is satisfied, the fans and spray pumps will cycle off.

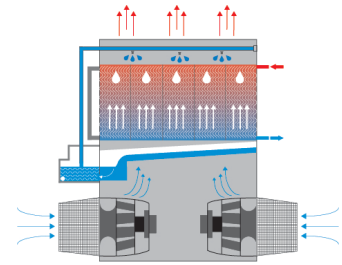

Nexus mode

In the revolutionary Nexus mode, you can prioritize water and energy savings to achieve the right balance of both. Your climate, cooling load profile and the rates you pay for water and energy will determine your specific settings, which can be easily adjusted as needed. You can specify the importance of water versus energy savings to automatically achieve the right balance for your specific situation.

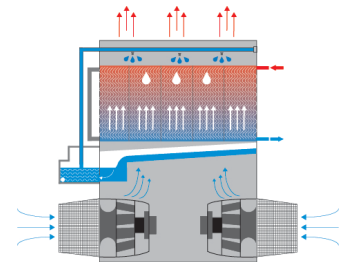



Water saver mode

In Water saver mode, water savings are maximized by applying spray water to the hCore™ heat exchanger automatically, intelligently and only when absolutely necessary to meet cooling requirements. The iPilot™ Control System applies water separately to each module, to minimize water usage and maximize savings.

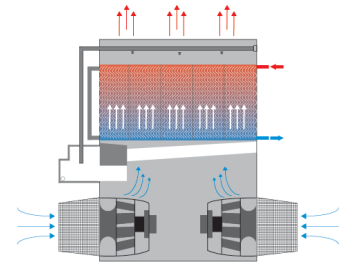

Want to use the NEXUS™ hybrid modular cooler to cool your process fluid? Contact your local [BAC representative](#) for more information.



Construction details

Closed circuit cooling towers

Construction details

1. Material options

- **Corrosion-resistant materials** come as standard for **maximum equipment life**:
 - The unique [Baltibond hybrid coating](#) is standard for all structural components. The hybrid polymer coating is applied pre-assembly to all hot-dip galvanized steel components of the unit.
 - The hCore™ heat exchanger is made of a highly corrosion-resistant, proprietary stainless steel alloy.
- **Optional [stainless steel](#)** panels and structural elements of type 304L and 316L for extreme applications.
- Or the economical alternative: a **water-contact stainless steel cold water basin**. Its key components and the basin itself are stainless steel. The rest is protected with the [Baltibond hybrid coating](#).



2. Heat transfer media

Using a highly corrosion-resistant stainless steel alloy, BAC's patented **hCore™ Heat Transfer Technology** provides unmatched performance, exceptional reliability and long life in an incredibly compact package.



hCore™ Heat Transfer Technology

- Proprietary stainless steel alloy exceeds M9540P salt spray environment cyclic corrosion testing at 100 times the typical water chemistry at 82°C.
- **Eliminates the need for passivation** and the potential for white rust.
- Engineered and manufactured for a **10 bar working pressure**.
- Fully-welded with robotic automation for **highest quality and maximum reliability**.
- Innovative heat transfer surface pattern for **maximum wet and dry performance**.

3. Air movement system

- The air movement system of each individual module consists of one or two **direct driven radial fans** made of aluminium, mounted on **EC motors with integrated control electronics**. They are completely **maintenance free** and guarantee redundancy.
- Compact, swing-out design allows easy access and inspection.
- EC motors have a **superior efficiency** that exceeds the requirements of efficiency class IE4. Integrated electronics of EC motors permit variable speed control for maximum system efficiency, at a significant reduced power consumption compared to AC motors with VFD.
- **High external static capacity** for indoor applications.
- Energy efficient radial fans give up to **40% savings** versus standard centrifugal fans.
- Our **drift eliminators** come in UV-resistant plastic, which will not rot, decay or decompose and their performance is tested and **certified by Eurovent**. They are assembled in **modules for easy removal from the side**.

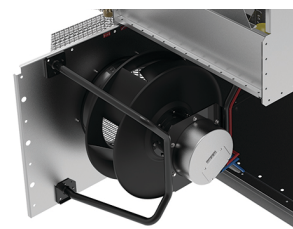

4. Water distribution system

The patent-pending DiamondClear™ Design is a water management system without stagnant water inside the unit. This provides continuous self-cleaning, significantly cutting water basin maintenance and water treatment costs by reducing scale build-up and biological growth.



- Patent pending, **high performance spray system** resists clogging and delivers proper water coverage for reducing scaling. Spray branches have wide, non-clog plastic nozzles secured by rubber grommets. You can easily remove, clean and flush both nozzles and spray branches from outside the unit.
- **Sloped spray water collection system** diverts water to the compact spray water basin, reducing spray water system volume by 60% and **eliminating stagnant water** inside.
- Pressurized, turbulent flow of spray water into the **compact external basin** eliminates the need for sweeper piping and allows **inspection during operation**.
- Spray water basin has an **automated, conductivity-based blowdown system**, with a programmable drain cycle that reduces maintenance.
- Fully-enclosed design is **protected from sunlight, helping eliminate biological growth**.
- Each module has its own SST 304 submersible pump that can be piloted individually to enable a mix of dry and evaporative modules.

5. iPilot™ Control System

BAC innovative iPilot™ Control System enables multiple modes of operation to tailor water and energy performance to your needs. The embedded intelligence gives you the ability to **effectively balance water and energy savings** and achieve the lowest possible operating costs.

- **Plug and play**, factory set customs controls. All electrical components are pre-wired in the factory to an IP66 electrical panel with Integrated Programmable Logic Controller (PLC) and Human Machine Interface (HMI).
- All **site specific parameters are factory set and tested** before the unit is shipped.
- **Easy Building Management System (BMS) integration** including MODBUS, BACnet and LONWORKS.
- Allowing you to tune your water and energy saving preferences based on your climate, operating conditions and the prices you pay for water and energy.

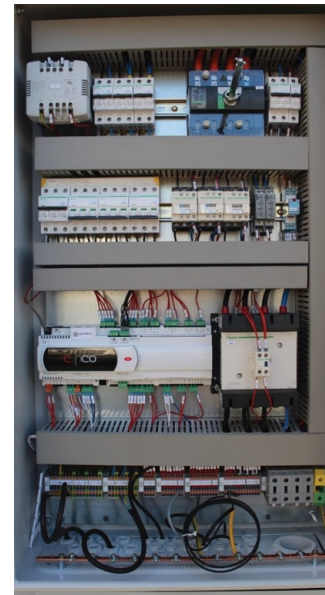

6. Modular Design

The modular design and exclusive iPilot™ Control System of the Nexus™ enable **multiple modes of operation to balance water and energy savings**. Its flexible, robust design is ideal for confined layouts and indoor applications. The lightweight, compact modules can easily be maneuvered with a pallet jack and fit into most freight elevators.

- Numerous layout options, up to six modules per unit
- Possibility to ship as completely assembled units or individual modules
- Future expandability by adding modules
- No special rigging equipment required

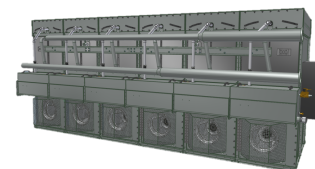

Need more information? Contact your local [BAC representative](#).



Options and accessories

Closed circuit cooling towers

Options and accessories

Below is a listing of the main Nexus options and accessories. If your required option or accessory is not listed, look no further than your [local BAC representative](#).

Water Treatment Solutions

Discover the water treatment solutions available for the Nexus Modular Hybrid Cooler.



Electrical panel heater

Protects electronic components in the iPilot™ electrical panel during extremely cold temperatures.



Basin heater package

Our factory-installed heaters prevent the cold water basin from freezing and damaging the unit during shutdown or standby.



Flanges

Flanges facilitate **piping connections** on-site.



Positive closure dampers

Use positive closure dampers (PCD) **to minimize the heatloss due to convection** by preventing airflow through equipment that is shut down.

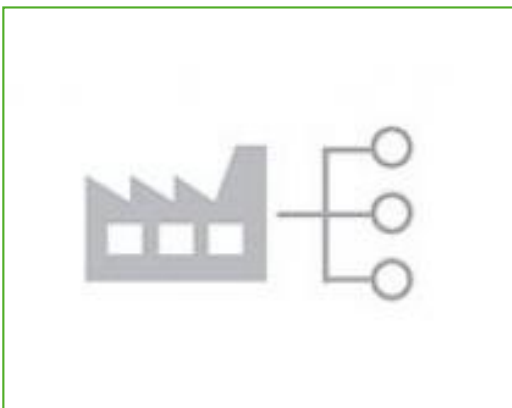

BMS supervision

This option integrates the iPilot™ Control System in your Building Management System (BMS).



Side stream UV system

The side stream UV system provides a factory installed chemical free biocide system, further guaranteeing the operational safety of the Nexus modular hybrid cooler.



NXF 0403E-CS2Tx-

Closed circuit cooling towers

XX

Engineering data

Remark: Do not use for construction. Refer to factory certified dimensions & weights. This page includes data current at time of publication, which should be reconfirmed at the time of purchase. In the interest of product improvement, specifications, weights and dimensions are subject to change without notice.

General notes

1. Dimensions listed are maximum values for the standard arrangement and at maximum flow. For precise values refer to certified print.

[NXF performance at standard conditions - 30% EG](#)

[NXF performance at standard conditions - 30% PG](#)

[NXF performance at standard conditions - 30% water](#)

[NXF - pressure drop](#)

Last update: 01/06/2023

NXF 0403E-CS2Tx-xx

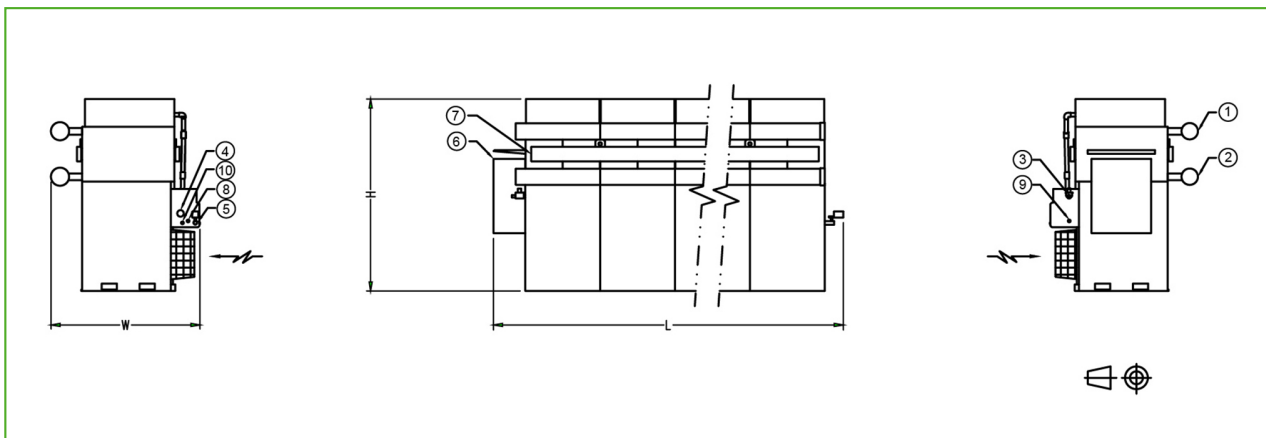

1. Fluid in; 2. Fluid out; 3. Make up; 4. Overflow; 5. Drain; 6. Control Panel; 7. Lifting beam; 8. Conductivity probe; 9. Treated water in; 10. Water treatment draw off.



Model	Number of modules	Weights (kg)		Dimensions (mm)			Air Flow (m ³ /s)	Fan Motor (kW)	Water Flow (l/s)	Pump Motor (kW)	HX Volume (L)
		Oper. Weight (kg)	Ship. Weight(kg)	L	W	H					
NXF 0 403E-C S2TS- H1	1	1236	1039	1643	2064	2585	4.0	(1x) 3.73	(1x) 2.0	(1x) 0.25	(2x) 50
NXF 0 403E-C S2TT- H1	1	1183	1007	1643	2064	2585	4.0	(1x) 3.73	(1x) 2.0	(1x) 0.25	(2x) 50
NXF 0 403E-C S2TS- H2	2	2455	2014	2647	2064	2585	7.9	(2x) 3.73	(2x) 2.0	(2x) 0.25	(4x) 50
NXF 0 403E-C S2TT- H2	2	2369	1979	2647	2064	2585	7.9	(2x) 3.73	(2x) 2.0	(2x) 0.25	(4x) 50
NXF 0 403E-C S2TS- H3	3	3646	2985	3650	2064	2585	11.9	(3x) 3.73	(3x) 2.0	(3x) 0.25	(6x) 50
NXF 0 403E-C S2TT- H3	3	3514	2930	3650	2064	2585	11.9	(3x) 3.73	(3x) 2.0	(3x) 0.25	(6x) 50
NXF 0 403E-C S2TS- H4	4	4895	3983	4653	2064	2585	15.9	(4x) 3.73	(4x) 2.0	(4x) 0.25	(8x) 50
NXF 0 403E-C S2TT- H4	4	4706	3906	4653	2064	2585	15.9	(4x) 3.73	(4x) 2.0	(4x) 0.25	(8x) 50
NXF 0 403E-C S2TS- H5	5	6137	4974	5657	2064	2585	19.9	(5x) 3.73	(5x) 2.0	(5x) 0.25	(10x) 50
NXF 0 403E-C S2TT- H5	5	5889	4873	5657	2064	2585	19.9	(5x) 3.73	(5x) 2.0	(5x) 0.25	(10x) 50
NXF 0 403E-C S2TS- H6	6	7379	5966	6660	2064	2585	23.8	(6x) 3.73	(6x) 2.0	(6x) 0.25	(12x) 50
NXF 0 403E-C S2TT- H6	6	7072	5840	6660	2064	2585	23.8	(6x) 3.73	(6x) 2.0	(6x) 0.25	(12x) 50

NXF 0603E-CS2Tx-xx

Closed circuit cooling towers

Engineering data

Remark: Do not use for construction. Refer to factory certified dimensions & weights. This page includes data current at time of publication, which should be reconfirmed at the time of purchase. In the interest of product improvement, specifications, weights and dimensions are subject to change without notice.

General notes

1. Dimensions listed are maximum values for the standard arrangement and at maximum flow. For precise values refer to certified print.

[NXF performance at standard conditions - 30% EG](#)

[NXF performance at standard conditions - 30% PG](#)

[NXF performance at standard conditions - 30% water](#)

[NXF - pressure drop](#)

Last update: 01/06/2023

NXF 0603E-CS2Tx-xx

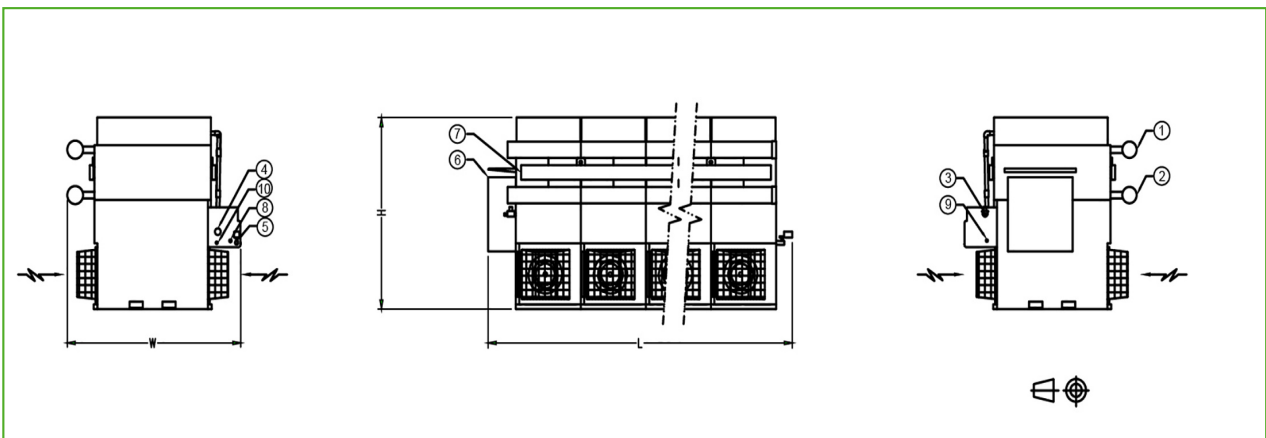

1. Fluid in; 2. Fluid out; 3. Make up; 4. Overflow; 5. Drain; 6. Control Panel; 7. Lifting beam; 8. Conductivity probe; 9. Treated water in; 10. Water treatment draw off.



Model	Number of modules	Weights (kg)		Dimensions (mm)			Air Flow (m³/s)	Fan Motor (kW)	Water Flow (l/s)	Pump Motor (kW)	HX Volume (L)
		Oper. Weight (kg)	Ship. Weight(kg)	L	W	H					
NXF 0 603E-C S2TS- J1	1	1736	1455	1643	2741	2585	6.1	(2x) 2.8	(1x) 3.2	(1x) 0.4	(2x) 74
NXF 0 603E-C S2TT- J1	1	1683	1423	1643	2741	2585	6.1	(2x) 2.8	(1x) 3.2	(1x) 0.4	(2x) 74
NXF 0 603E-C S2TS- J2	2	3455	2847	2647	2741	2585	12.2	(4x) 2.8	(2x) 3.2	(2x) 0.4	(4x) 74
NXF 0 603E-C S2TT- J2	2	3369	2812	2647	2741	2585	12.2	(4x) 2.8	(2x) 3.2	(2x) 0.4	(4x) 74
NXF 0 603E-C S2TS- J3	3	5151	4240	3650	2741	2585	18.2	(6x) 2.8	(3x) 3.2	(3x) 0.4	(6x) 74
NXF 0 603E-C S2TT- J3	3	5019	4184	3650	2741	2585	18.2	(6x) 2.8	(3x) 3.2	(3x) 0.4	(6x) 74
NXF 0 603E-C S2TS- J4	4	6915	5669	4653	2741	2585	24.3	(8x) 2.8	(4x) 3.2	(4x) 0.4	(8x) 74
NXF 0 603E-C S2TT- J4	4	6726	5592	4653	2741	2585	24.3	(8x) 2.8	(4x) 3.2	(4x) 0.4	(8x) 74
NXF 0 603E-C S2TS- J5	5	8662	7082	5657	2741	2585	30.4	(10x) 2.8	(5x) 3.2	(5x) 0.4	(10x) 74
NXF 0 603E-C S2TT- J5	5	8414	6981	5657	2741	2585	30.4	(10x) 2.8	(5x) 3.2	(5x) 0.4	(10x) 74
NXF 0 603E-C S2TS- J6	6	10404	8490	6660	2741	2585	36.5	(12x) 2.8	(6x) 3.2	(6x) 0.4	(12x) 74
NXF 0 603E-C S2TT- J6	6	10097	8364	6660	2741	2585	36.5	(12x) 2.8	(6x) 3.2	(6x) 0.4	(12x) 74